

# OPTONICA

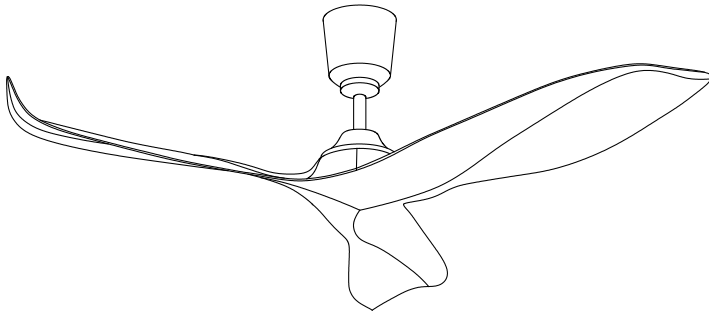

## INSTALLATION GUIDE







## CAUTIONS AND WARNINGS

- Read this manual instruction carefully before installation, and keep the instruction.
- Use only original replacement parts.
- To reduce the risk of personal injury, attach the fan directly to the support structure of the building according to these instructions, and use only the hardware supplied.
- To avoid possible electrical shock, before installing your fan, disconnect the power by turning off the circuit breakers to the outlet box and associated wall switch location. If you can't lock the circuit breakers in the off position, securely fasten a prominent warning device, such as a tag, to the service panel.
- All wiring must be in accordance with national and local electrical codes and ANSI/NFPA 70. If you are unfamiliar with wiring, use a qualified electrician.
- To reduce the risk of personal injury, do not bend the blade attachment system when installing, balancing, or cleaning the fan. Never insert foreign objects between rotating fan blades.
- To reduce the risk of fire, electrical shock, or motor damage, do not use a solid-state speed control with this fan. Use only original speed control.

1

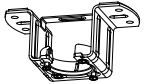
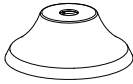
### Parts Inventory

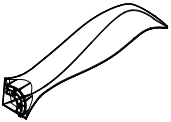
Carefully open the package. Remove items from package inserts. Remove motor housing and place on carpet or soft material to avoid damage. Check again all parts inventory to make sure all parts have been included.

|   |   |   |
|---|---|---|
|  |  |  |
| Canopy  | Downrod and hanging ball  | Spiral package  |
|  |  |  |
| Hanger bracket  | Decorative covers   | Motor   |
|  |  |   |
| Blade   | Remote control  |   |

### Installation Preparation

To prevent personal injury and damage, ensure that the hanging location allows the blades a clearance of 2.3m from the floor and 76cm from any wall or obstruction. Be sure the outlet box is securely attached to the building structure and can support the full weight of the fan.

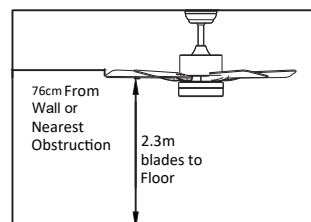

2

### Preparing the Fan Site

#### Downrod Installation

This fan can be mounted with a downrod on a normal or vaulted ceiling. The hanging length can be extended by a longer downrod.

Installation requires these tools:

Screwdriver, flat-head screwdriver, adjustable pliers or wrench, step ladder, wire cutter and rated electrical tape.

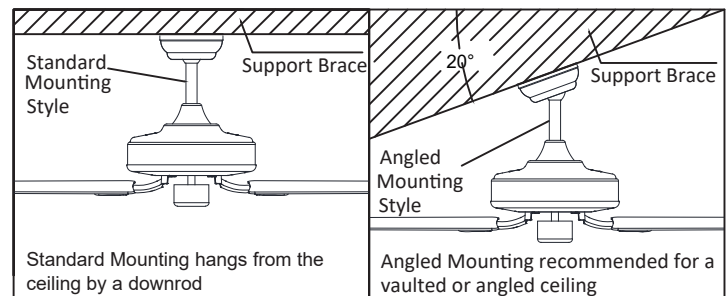

### Installing the Hanger Bracket

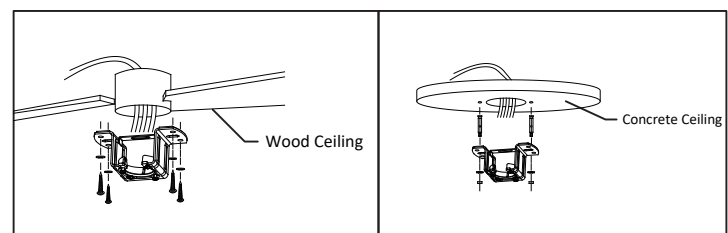

Please drill  $\phi 8\text{mm}$  hole on the concrete ceiling, and insert the bolt. Align bracket with the hole, then tighten with nut.

3

## Assembling and Hanging the Fan

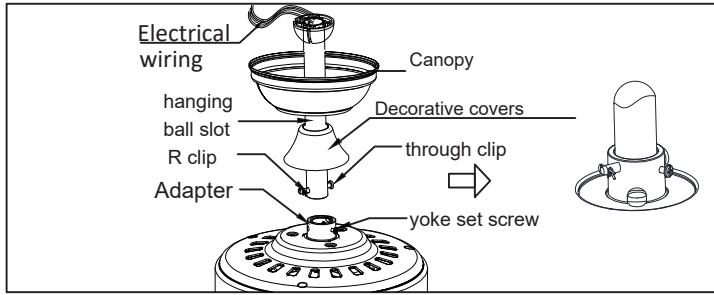

If you wish to extend the hanging length of your fan, you must remove the hanging ball from the 6 inch downrod provided to use with an extended downrod (selected). (If you wish to use the 6 inch downrod, please proceed to instructions below.)

To remove hanging ball, loose set screw on hanging ball and remove pin and clip. Lower hanging ball and remove stop pin. Slide hanging ball off the original downrod A, and slide it down the longer downrod (the top of the downrod should be noted as having a set screw hole; use this hole when setting the set screw). Insert stop pin into top of extended downrod and raise hanging ball. Be sure stop pin aligns with slots on the inside of the hanging ball, tighten set screw securely.

Tip: To prepare for threading electrical wires through downrod, apply small piece of electrical tape to the ends of electrical wires, this will keep the wires together when threading them through the downrod.

Loosen yoke set screws and nut at top of motor housing. Remove pin and clip from downrod (if you have not already done so). Slide downrod through canopy.

Tread electrical wires through downrod and pull extra wire slack from the upper end of the downrod.

Place downrod into the motor housing yoker and insert pin and clip which were previously removed. Tighten yoker set screws and nut securely. Lower canopy to motor housing.

4

## Remote control connection

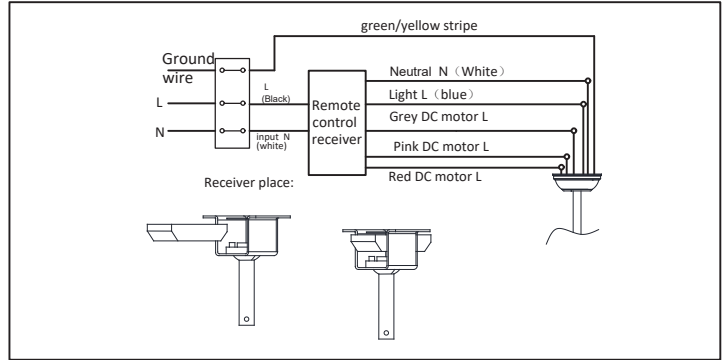

## Canopy Assembly

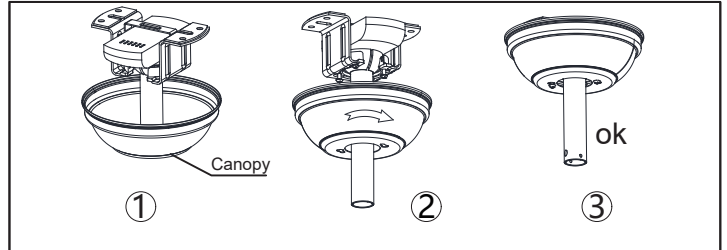

Raise canopy to hanging bracket, aligning loosened screws in hanging bracket with slotted holes in canopy. Twist canopy to lock. Re-insert screws and secured all screws with screwdriver.

With hanging bracket secured to the outlet box and able to support to fan, you are now ready to hang your fan. Grab the fan firmly with two hands. Slide downrod through opening in hanging bracket and let hanging ball rest on the hanging bracket. Turn the hanging ball slot until it lines up with the hanging bracket tab.

Tip: Seek the help of another person to hold the stepladder in place and to lift the fan up to you once you are set on the ladder.

5

## Blade Assembly

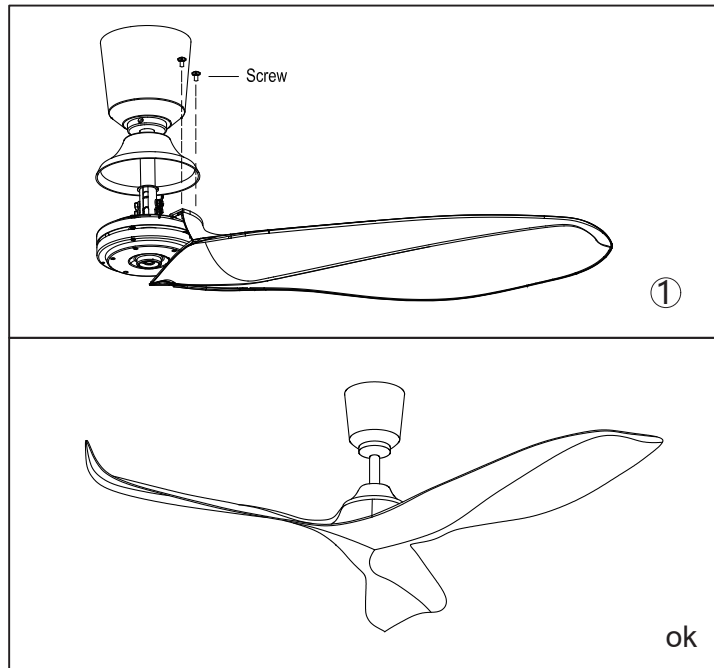

Screw the fan blade with Iron A and lock with Iron B, Do not lock the screw tight at one time until 8 blades are fixed. Install the fan blades into the motor.

IMPORTER: Prima Group 2004 LTD, Bulgaria, 1582 Sofia, Druzha 2, Blvd. "Prof. Tsvetan Lazarov" 126A, 4th floor; Phone: +359 2 988 45 72;

6

7